Operator's Instruction Manual



C500 20 thru 100

CLARK[®]

BOOK NO. OI-328-REV. 4
2385900

! WARNING

- FOR YOUR SAFETY AND THE SAFETY OF OTHERS.
- BEFORE YOU OPERATE THIS TRUCK!
- READ ALL WARNINGS AND INSTRUCTIONS IN THE OPERATOR'S MANUAL AND ON THE TRUCK.
- CHECK THE TRUCK FOR CORRECT OPERATION.
- DO NOT OPERATE THIS TRUCK UNLESS YOU ARE TRAINED AND AUTHORIZED TO DO SO.

IMPORTANT

Do not expose this manual to hot water or steam.

The following warnings are provided pursuant to California Health & Safety Code Sections 25249.5 et. seq:

! WARNING

California Proposition 65

This product contains and emits chemicals known to the State of California to cause cancer, birth defects and other reproductive harm.

CALIFORNIA

Proposition 65 Warning

Diesel engine exhaust and some of its constituents are known to the State of California to cause cancer, birth defects or other reproductive harm.

! WARNING

The engine exhaust from this product contains chemicals known to the State of California to cause cancer, birth defects or other reproductive harm.

FOREWORD

Federal and state laws require that operators be completely trained in the safe operation of lift trucks.

Before you start operating this lift truck, make sure that you understand all driving procedures. It is important to operate your lift truck safely and efficiently.

This manual will help you learn how to operate your lift truck. This manual describes the controls, special features and the functions of each control.

This manual is not a training manual, it is a guide to help authorized operators safely operate a lift truck. Illustrations in this manual show the operator correct procedures for checking, starting, operating and stopping the lift truck.

Clark lift trucks are built to take hard work, but not abuse. They are built to be dependable but as with any lift truck, they are only as efficient as the operator and the persons responsible for maintaining them.

Do not make any repairs to this lift truck unless you have been trained in lift truck repair procedures and authorized by your employer.

MANUALES DE INSTRUCCIÓN PARA OPERADORES IMPRIMIDOS EN ESPAÑOL SON OBTENIDOS DE SU DISTRIBUIDOR CLARK.

BETRIEBSANWEISUNGEN IN DEUTSCHER SPRACHE KOENNEH SIE BEI IHREM CLARK-HAENDLER ERHALTEN.

MANUELS DE L'OPERATEUR EN LANGUE FRANCAISE PEUVENT ETRE COMMANDES CHEZ VOTRE DISTRIBUTEUR CLARK.

TABLE OF CONTENTS

Operator's Warning	Page 0
Foreword	Page i
Drive Safely	Page 2
Summary of Safe Operating Procedures	Page 3
Clarklift C500	Page 4
Safety	Page 5
Truck Tip-Over	Page 16
Know Your Truck	Page 18
Major Components	Page 18
Data and Capacity Plate	Page 19
Controls — Column Mounted Levers	Page 20
Controls — Console Mounted Levers	Page 21
Instruments and Gauges	Page 22
Hand Controls	Page 24
Hydraulic Controls	Page 26
Transmission Controls	Page 28
Operating the Hydratork® Transmission	Page 31
Operating the Manual Shift Transmission	Page 32
Operator's Daily Checklist	Page 35
Engine Starting Procedure	Page 42
Gasoline and L.P. Gas	Page 42
Diesel	Page 44
Stopping and Parking	Page 45
Helpful Hints	Page 46
Wheel and Tire Maintenance Safety Messages	Page 49
Truck Reference Data	Page 52

DRIVE SAFELY

BEFORE YOU OPERATE THIS LIFT TRUCK, READ AND UNDERSTAND THE INSTRUCTIONS, SIGNS AND MESSAGES IN THIS MANUAL AND ON THE LIFT TRUCK.

INJURY OR DEATH TO YOU OR OTHER PERSONNEL WILL OCCUR IF YOU DO NOT FOLLOW THESE INSTRUCTIONS AND MESSAGES.

STAY ALERT!

SUMMARY OF SAFE OPERATING PROCEDURES

1. Do not operate this truck unless you have been trained and authorized to do so. Read all warnings and instructions in operator's manual and on this truck.

2. Do not operate this truck until you have checked its condition. Give special attention to Tires, Horn, Lights, Battery, Controller, Lift and Tilt Systems including forks and attachments, chains, cable and limit switches, brakes, steering mechanism, fuel system, and guards.

3. Operate truck only from designated operating position. Never place any part of your body into the mast structure, between the mast and the truck, or outside the truck. Do not carry passengers.

4. Do not operate truck without overhead guard, unless conditions prevent use of a guard. Use special care if operation without overhead guard is required.

5. Do not handle loads which are higher than the load backrest or load backrest extension unless load is secured so that no part of it could fall backward.

6. Do not handle unstable or loosely stacked loads. Use special care when handling long, high or wide loads to avoid losing

the load, striking bystanders, or tipping the truck.

7. Do not overload truck. Check capacity plate for load weight and load center information.

8. Lift trucks will tip over if not properly operated. Start, stop, travel, steer and brake smoothly. Slow down for turns and on uneven or slippery surfaces that could cause truck to slide or overturn. Use special care when traveling without load as the risk of overturn is greater.

9. Elevate forks or other lifting mechanism only to pick up or stack a load. Lift and lower with mast vertical or tilted slightly back — NEVER FORWARD. Watch out for obstructions, especially overhead.

10. Operate tilting mechanism slowly and smoothly. Do not tilt forward when elevated except to pick up or deposit a load. When stacking, use only enough backward tilt to stabilize load.

11. Travel with load or lifting mechanism as low as possible and tilted back. Always look in direction of travel. Keep a clear view and when load interferes with visibility, travel with load or lifting mechanism trailing (except when climbing ramps).

12. Use special care when operating on ramps — travel slowly, and do not angle or turn. When truck is loaded, travel with load uphill. When truck is empty, travel with lifting mechanism downhill.

13. Observe applicable traffic regulations. Yield right-of-way to pedestrians. Slow down and sound horn at cross aisles and wherever vision is obstructed.

14. When using forks, space forks as far apart as load will permit. Before lifting, be sure load is centered and forks are completely under load.

15. Do not allow anyone to stand or pass under load or lifting mechanism.

16. Do not lift personnel on the forks or on a work platform. Use a manlift specifically designed for this purpose. When operating rider order selector trucks, attach the safety chain to the overhead guard and put the safety belt on.

17. Before getting off truck, neutralize travel control, fully lower lifting mechanism and set parking brake. When leaving truck unattended, also shut off power.



11312M

11311M

CLARKLIFT C500 MODELS WITH RATED CAPACITIES FROM 2000 LBS. THROUGH 10000 LBS. Pneumatic or cushion tires; Hydratork® (power shift) or manual shift transmissions. Choice of Gas, L.P. Gas, or Diesel engines on most models.

Safety

BE A PRO!

Like any professional you must be thoroughly trained to operate a fork truck. Your ability to prevent accidents is an important part of your job.



KEEP YOUR FORKS DOWN!

One of the first things you must learn is never to drive your lift truck with the forks raised. You might hurt someone or damage valuable merchandise.



LEARN YOUR JOB!

Practice turning, backing down ramps, operating in narrow confines, stacking. Develop confidence in yourself and your equipment.



OBEY THE LAW!

Observe regular traffic rules. Keep to the right; don't follow too close; keep your truck under control and avoid sharp turns.



Safety



IF YOU CAN'T SEE, BACK UP!

If a load is too high or too wide to see around, drive the lift truck backwards. But take it easy, and watch for people and obstructions on both sides.

LOOK UP!

Keep an eye overhead . . . you can damage sprinkler systems and pipes. This isn't the time or place for a shower.



CHECK FLOOR CAPACITY

Be sure that elevators and floors in trucks and freight cars will support the combined weight of your truck and the load it is carrying.

NO RIDERS... EVER

The quick response of a lift truck will cause riders to fall off. Besides, they distract you and this could be dangerous. Hang the "No Riders" sign right away.



Safety

BE ALERT!

Obey all traffic signs and aisle markers. Slow down at aisle intersections and in crowded areas where people may step in front of you. Blow your horn at blind corners.



PROTECT YOURSELF!

An overhead guard provides protection against personal injury. A load backrest extension helps protect the operator from spilled loads.



STAY CLEAR OF THE EDGE!

Stay away from the edge of loading docks. One little slip and you call for a medic.



SPACE FORKS TO FIT LOAD

To maintain proper balance, load should be centered and forks should be near the outside edges. It's easy to make the move and may save a move to the hospital.



Safety



KEEP INSIDE!

Never drive a lift truck with your legs, or any other part of your body, outside the running lines of the truck.

NO SMOKING!

When refueling, never smoke or light a match. Shut off the engine and douse your cigarette. Always clean up spilled fuel before re-starting engine.



KEEP CLEAR!

Never put your head, hands or feet into the upright for any reason. Don't allow anyone to stand, walk or sit under the forks.

Do not move or raise personnel on the forks of a lift truck. Use a manlift specifically designed for this purpose.



Safety

DON'T DAYDREAM!

Keep your mind on your work. Learn to anticipate danger before it arises.



CHECK YOUR PLATES!

Be sure bridge plates onto trucks and freight cars are properly in place and secure. Also, trucks and railroad cars should have their wheels blocked to prevent them from rolling.



KEEP IT CLEAN AND READY TO GO!

Check gauges, horn, upright and controls before you start. Inspect fuel, oil and water levels. Take pride in operating a good, clean truck.



REPORT ALL TROUBLES!

Report faulty truck performance to your supervisor. Don't try to make repairs yourself.



Safety

HELP PREVENT ACCIDENTS!

When you park your machine, lower the forks so they're flat on the ground. Develop the habit; it's very important.



STOP, THEN BACK UP!

Always come to a full stop before reversing direction of travel. Your truck can reverse quickly, you can't.



EASE INTO THE LOAD!

Don't blast into stacked goods; like a fullback. In fact, don't even nudge them with forks or rear end of truck — you might damage the goods and the operator.



DON'T LIFT UNSTABLE LOADS.

Obviously unstable loads should be repiled or banded. Once they are on the move, it's too late.



Safety

KEEP EYES FRONT!

Always remember the most important rule of the road: Look where you're going. Wandering eyes mean a wandering truck, and that could be dangerous.



BACK DOWN RAMPS!

It's risky to drive down a ramp load first. Your truck can tip forward if the ramp is steep enough. Always back down in low gear and never turn sideways on an incline.



PICK UP ALL THE LOAD!

Be sure your forks are all the way under the load. A spilled load means lost production time as well as material damage.



TILT IT BACK!

Load should be tilted back until it rests securely for traveling. A load backrest extension gives added protection against spilling loads.



Safety

GET 'EM UP . . .

Raise loads just high enough to clear all floor obstructions.

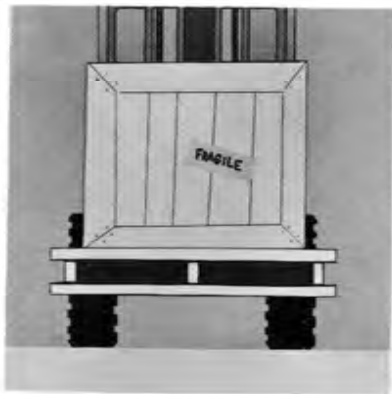

DON'T DOUBLE UP!

Don't handle double tiered loads. They're unstable and difficult to control. Even an overhead guard can't fully protect an operator from heavy objects dropped from this height.

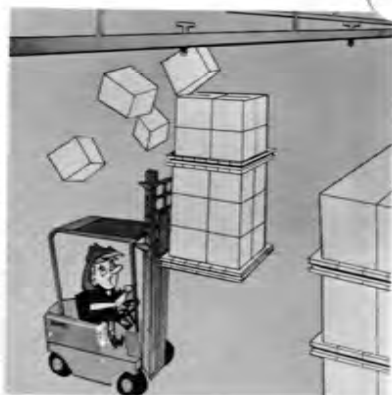

BREAK 'EM DOWN!

Overloading is extremely dangerous. You don't have complete control of your truck and you're causing unnecessary wear. Don't add counterweight, break down your load.



KEEP OTHERS OFF YOUR TRUCK!

Keep unauthorized people away from the controls of your truck. They could spoil a good safety record . . . fast.



Safety

DON'T BE HALF SAFE!

Under normal traffic conditions, keep to the right. Maintain a safe distance, approximately three truck lengths, from the truck ahead and keep your truck under control at all times.



EASY DOES IT!

Do not pass another truck traveling in the same direction at intersections, blind spots, and other dangerous locations.



HOLD IT!

Slow down and sound horn at cross aisles and other locations where vision is obstructed. Yield the right-of-way to ambulances, fire trucks and other vehicles in emergency situations.



WATCH OUT FOR TRAINS!

Use of truck on public roads shall conform to local regulations. Cross railroad tracks at an angle wherever possible. Do not park closer than eight feet from center of tracks.



Safety

SLOW

13103M

SLOW—FOR SAFETY

When operating surfaces are slippery due to rain, etc., slow down. Turning and high speeds can be dangerous.

Use minimum forward and reverse tilt when stacking and unstacking loads.

Never tilt forward unless load is over stack or at low lift height.



WARNING

BREAKING THESE RULES WILL CAUSE SERIOUS OR FATAL INJURY TO YOURSELF AND OTHERS.

- Do not operate this lift truck unless you are trained and authorized. Read and understand operator's manual before operating lift truck. Clark dealers have instructional manuals.
- Do not operate damaged or faulty lift truck. Do not attempt repairs unless you are trained and authorized.
- Look where you drive. Watch out for people, obstructions, especially overhead, and drooping or dead blocks your way. Drive backwards, except up slopes.
- Lift trucks will tip over if not properly operated. Slow down before turning. Do not turn on slopes. Drive with forks or attachments fully retracted and tilted back. Check tires for correct pressure.
- Forks or attachments can fall easily if not properly controlled or maintained. Do not use this lift truck to hoist people.
- Protect against falling objects. Overhead guard and load backrest extension must be in place.
- Do not load lift truck over capacity or unstable. Move long, high, or wide loads carefully. Do not move unstable loads.
- Before getting off lift truck, lower forks or attachments to the way, put down or retract, turn off key and set parking brake.

Prominently located on the truck is a list of basic safety rules. These rules are for your protection. Be familiar with them.

Inspect the seat for damage, and the seat belt for fraying and heavy wear.



24658

Safety



84M025

Lift the seat deck latch to make sure it locks the seat deck in position.



24874

Watch your lift chains when operating in storage racks. Slack chains mean rail or carriage hang-up. Raise the upright before you move.

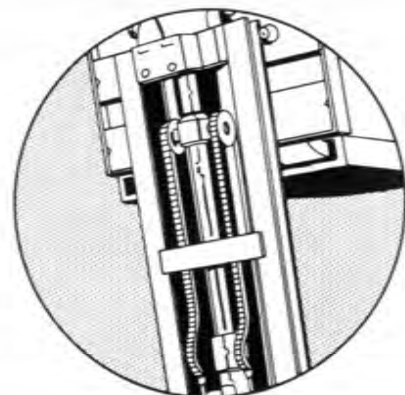

24875

When stacking:

1. Watch your lift chains.
2. If chains go slack, stop, raise load, lower again.

Truck Tip-Over



24965

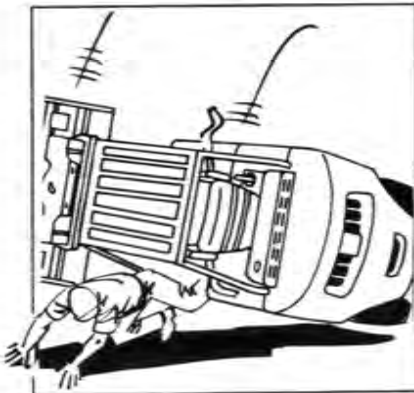

24966

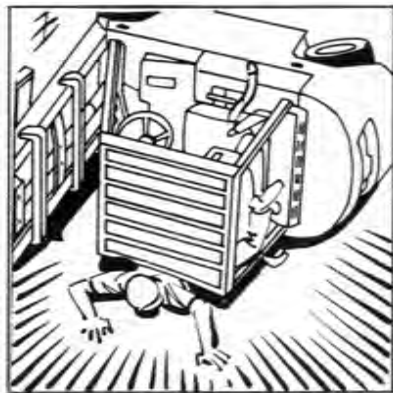

24967

This three-picture sequence shows what happens if an operator tries to jump from a truck during a tip-over.

If your truck starts to tip over, do not jump. Always buckle your seat belt.

Your chances for survival in a tip-over are better if you stay with the truck. The following page shows the position to take in the event of a tip-over.

Truck Tip-Over



24968

Know Your Truck

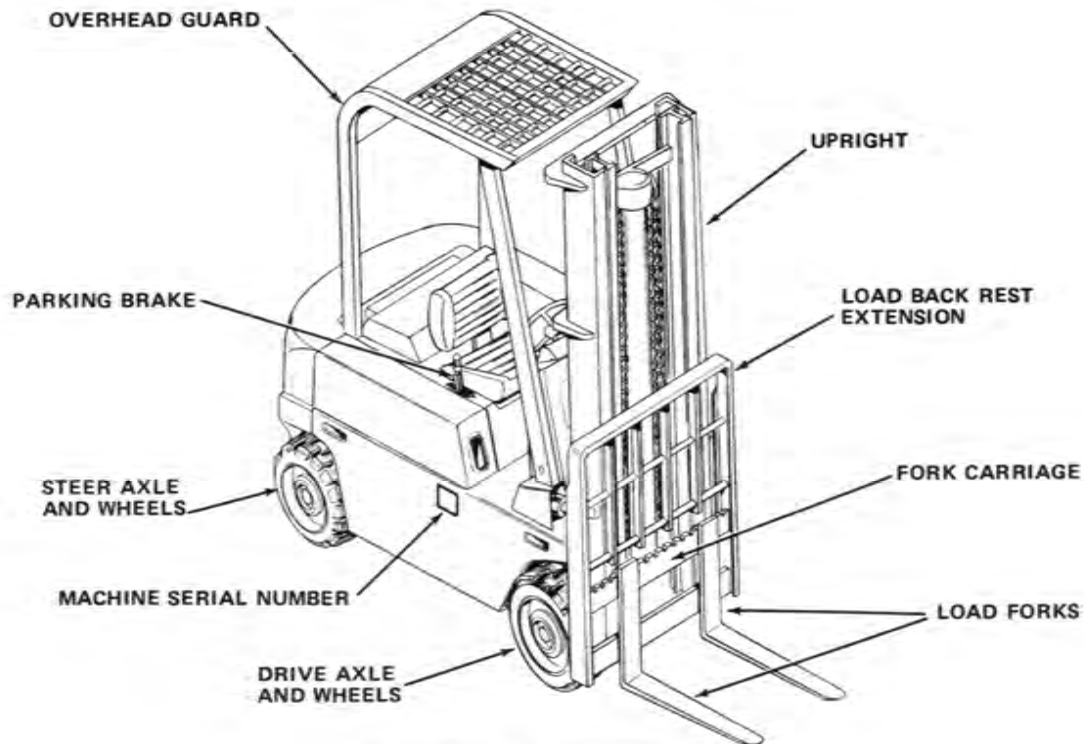

CLARKLIFT C500 MODELS
2000 lb. THRU 10000 lb. RATED CAPACITY

Know Your Truck

KNOW THE LOCATION OF YOUR TRUCK'S

CLARK EQUIPMENT	
INDUSTRIAL TRUCK DIVISION BATTLE CREEK MICHIGAN	
MODEL NO. <input type="text"/>	TYPE <input type="text"/>
SERIAL NO. <input type="text"/>	
ATTACHMENTS <input type="text"/>	
CAPACITY WITH ATTACH. LISTED ABOVE OR WITH FORKS - UPRIGHTS VERTICAL	
LBS A B C	
<input type="text"/>	
<input type="text"/>	
LESS BATT.-ELECTRICS <input type="text"/>	
WITH MAX. BATT. WT. <input type="text"/>	
MAX	MIN
AH	NO.
LBS	VOLTS
FOR OTHER CAPACITIES-CONSULT MANUFACTURER AS RELEASED FROM FACTORY THIS TRUCK MEETS THE DESIGN SPECIFICATIONS ESTABLISHED IN AMERICAN NATIONAL STANDARD FOR POWERED INDUSTRIAL TRUCKS, PART II, ANSI B 56 1-1969	
PT. NO. 2315709	

13217M

- 1 MODEL NUMBER.
- 2 TRUCK TYPE. The code letter(s) signifies type of fire protection construction. Check with proper authority before entering areas where inflammable or explosive material may be present.
- 3 SERIAL NUMBER.
- 4 ATTACHMENT DESCRIPTION (If any).
- 5 CAPACITY. Capacity, load center, and lifting height data are stamped in these areas. Do not exceed the maximum specified.
- 6 TRUCK WEIGHT LESS LOAD.

IMPORTANT: If the truck is modified so as to affect capacity; or, the plate damaged or defaced, get a new plate from your Clark Distributor.

DATA AND CAPACITY PLATE

Know Your Truck

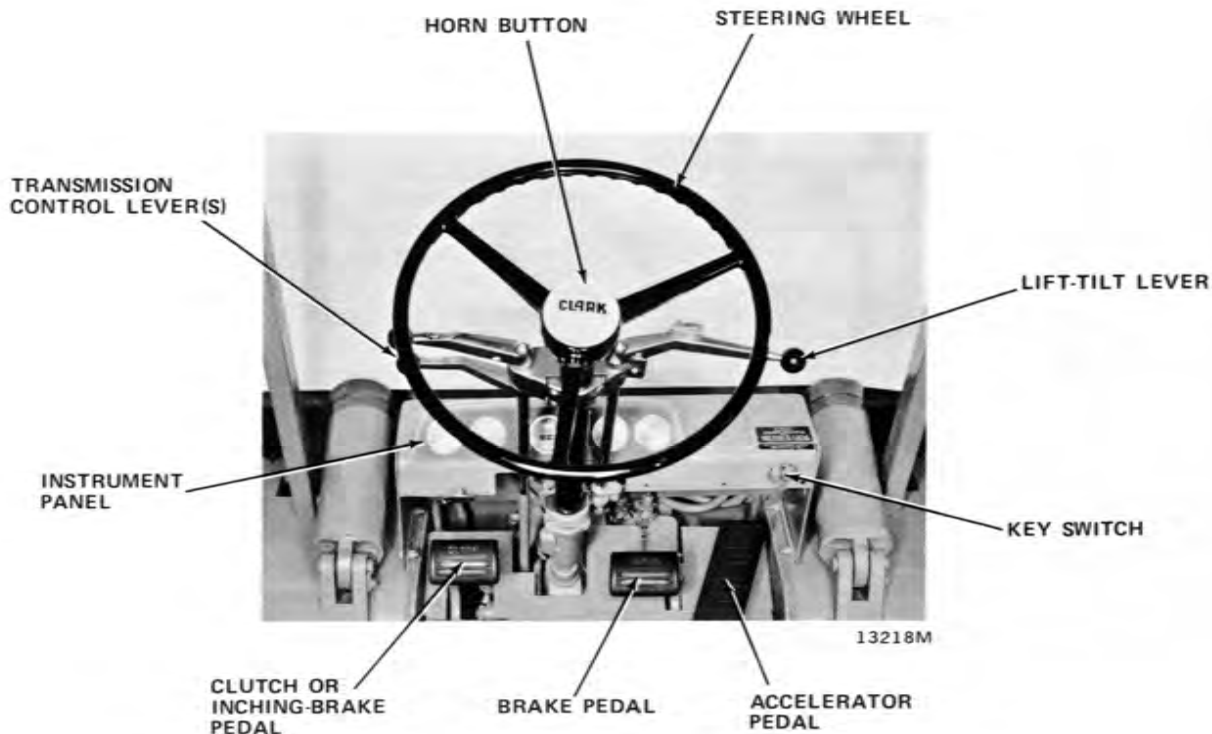

CONTROLS – COLUMN MOUNTED LEVERS

Know Your Truck

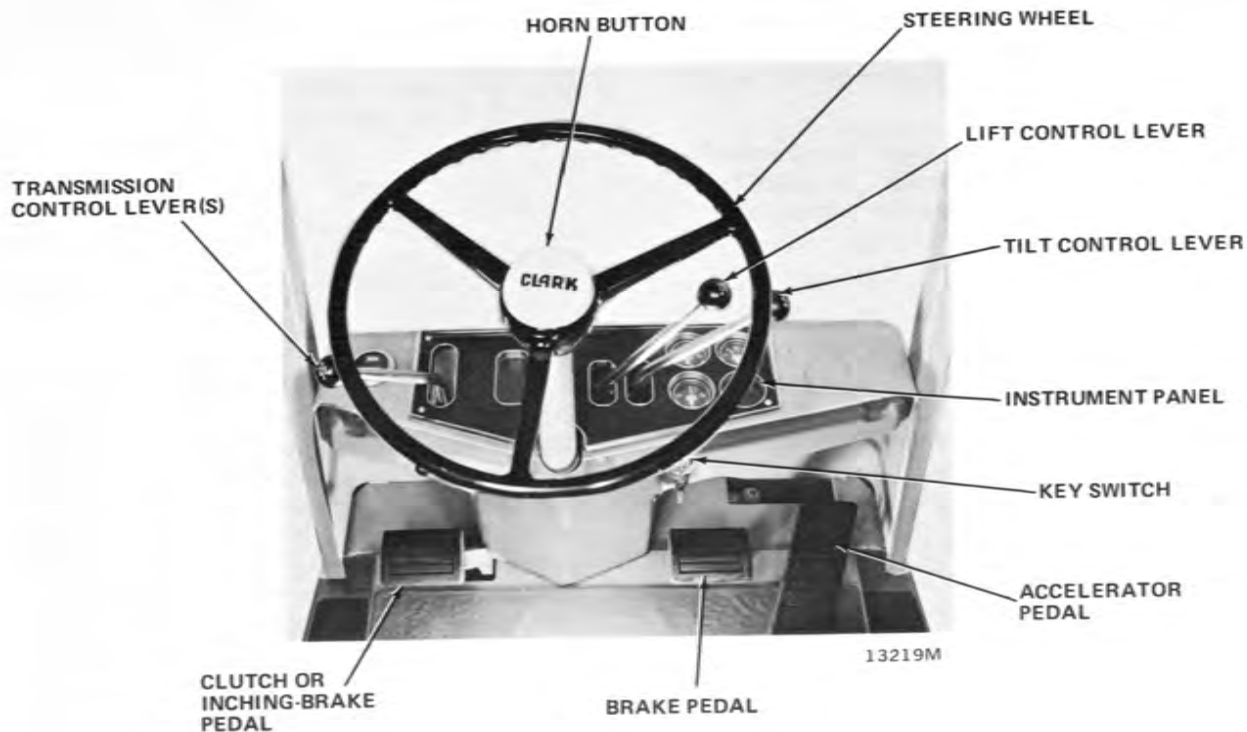

CONTROLS – CONSOLE MOUNTED LEVERS

Know Your Truck

The instruments, indicators and hour meter, conveniently grouped in the instrument cluster, are designed to tell you at a glance many important things about the performance of your vehicle.

Familiarize yourself with their location and purpose and make it a practice to scan the instrument cluster as you start the engine, after it starts, and periodically as you drive.

NOTE:

The electrically operated indicators register correctly when the ignition switch is in the "on" position. When the ignition switch is turned "off", the indicator needle will not necessarily return to any given position.

Report to the designated authority if any indicator is not functioning properly.

GAS AND DIESEL FUEL GAUGE

Fuel level should be checked at the beginning of each shift. Always start with a full tank.



13220M

13221M

LP GAS FUEL GAUGE

The LP Gas fuel gauge is located at the end of the tank. Percentage of fuel remaining is indicated. Tank should contain enough fuel to complete scheduled work shift.



INSTRUMENTS AND GAUGES

Know Your Truck



13222M
13223M

OIL PRESSURE GAUGE

Oil pressure should be between 20 and 60 PSI at normal engine operating speeds. At idle, pressure should not fall below 5 PSI. If pressure is low (on some models indicated by a dash light) or erratic, shut down engine until trouble is located.



WATER TEMPERATURE GAUGE

Water temperature should be about 180°F. after 10 min. of operation. If the indicator registers in the "hot" zone, turn off engine until trouble is located.

AMMETER

If the ammeter shows a continuous high rate of charge or discharge, or reads erratically, report trouble to proper authority.

NOTE: A high charge rate will be indicated for a brief time after engine is started.



13224M
13225M

HOUR METER

Total engine operating hours are registered on the hour meter. The indicated hours are used for planned maintenance. The total hours should be recorded at the beginning and end of each shift on the Driver's Daily Checklist.



INSTRUMENTS AND GAUGES

Know Your Truck

KEY SWITCH

A 3 position key switch is standard equipment. To start engine, rotate key clockwise. Release to "run" position when engine starts.

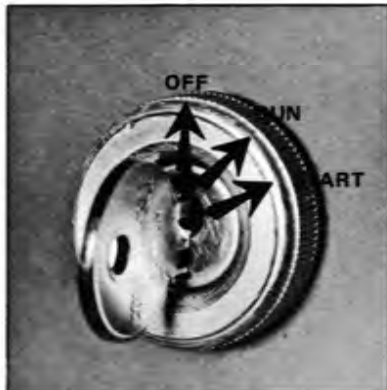

13226M
13227M

PARKING BRAKE

The parking brake should hold a fully loaded truck on a grade with an 18" rise in 10 ft. or the maximum grade negotiated in the operation, whichever is less. Tension can be regulated by rotating the knob on the lever.



13228M
13229M

DIESEL ENGINE STOP

An engine stop control is provided on Diesel models. To stop the engine, allow it to idle for a few moments then pull out stop control. After engine stops, push control in and turn key position to "off" position.

NOTE

Current models use an electric solenoid shut-off in place of the pull stop shown.



CHOKE CONTROL

The choke control is located either on the dash or next to the operator's seat. A choke control is not provided on Diesel models.



HAND CONTROLS

Work Safely

Drive Safely

Be Careful

Know Your Truck

The main hydraulic functions (lifting, lowering and tilting) are controlled by lever(s) conveniently located to permit operation by the driver's right hand. One of two arrangements has been provided on your lift truck . . . console mounted controls (located on the dash to the right of the steering column), or a single lever mounted on the right hand side of the steering column.

REFER TO THE FOLLOWING PAGES FOR CORRECT LEVER MOVEMENT—HYDRAULIC FUNCTION RELATIONSHIP. THE LEVER(S) WILL AUTOMATICALLY RETURN TO NEUTRAL WHEN RELEASED.

Trucks equipped with hydraulic attachments or accessories will have one or two additional control levers mounted on the right hand side of the dash. The function of these lever(s) should be checked with the proper authority.

BE COMPLETELY FAMILIAR WITH ALL HYDRAULIC FUNCTIONS BEFORE OPERATING THE TRUCK WITH A LOAD. LEARN TO PERFORM THESE FUNCTIONS IN A SMOOTH MANNER.

HYDRAULIC CONTROLS

Know Your Truck

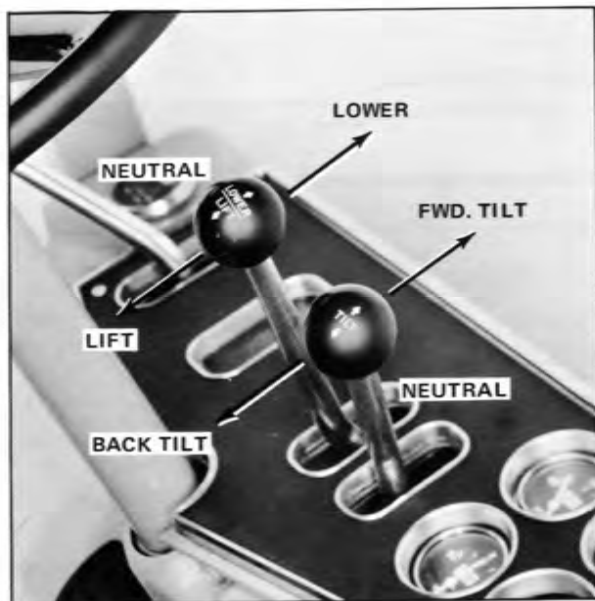

CONSOLE MOUNTED CONTROLS

13230M

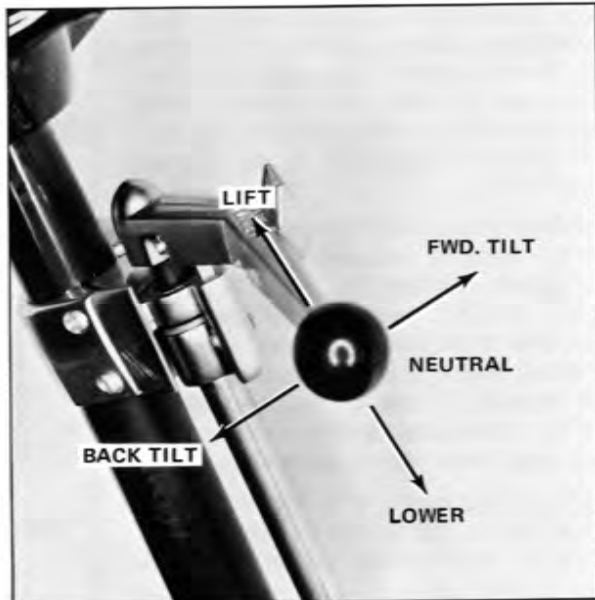

COLUMN MOUNTED CONTROLS

13231M

HYDRAULIC CONTROLS

Know Your Truck

Your Clarklift is equipped with either a Hydratork (power shift) or friction clutch (manual shift) transmission. Depending on model, the manual shift transmission will have a conventional dry clutch plate or one that is oil cooled (Hydracool®).

The Hydratork models have a left foot pedal to control inching and braking. The initial portion of pedal travel (approx. 1-1/2") regulates oil pressure within the transmission, thus allowing controlled truck speed independent of engine speed. Fast lifting and other hydraulic functions are possible while maintaining slow travel speeds.

Further depressing the inching-brake pedal actuates the service brake system. The right hand brake pedal controls service brakes only.

On manual shift models, the left pedal is for operating the clutch while shifting. Its operation is similar to that of an automobile.

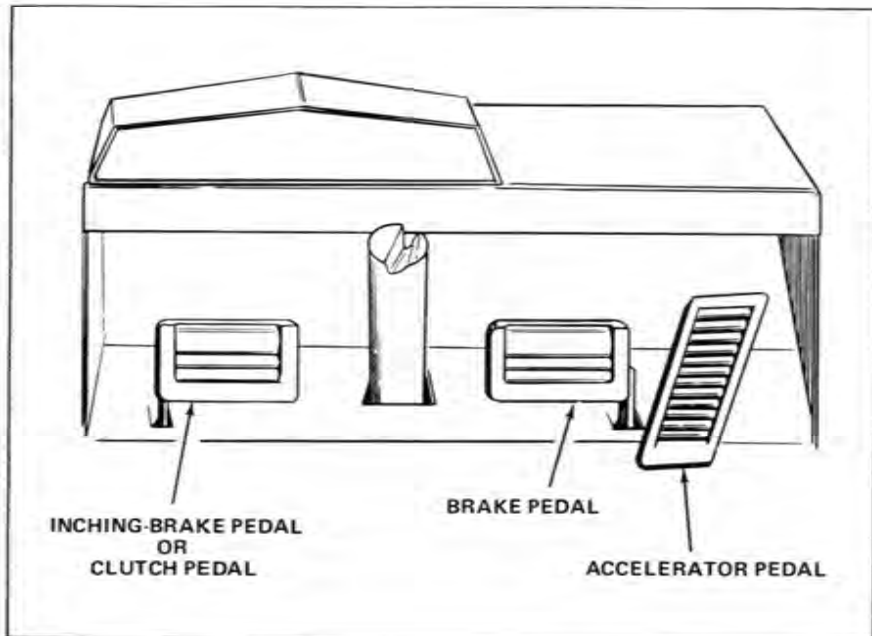

13232M

NOTE: Do not "Ride" the left foot inching brake pedal as transmission component life can be shortened.

TRANSMISSION CONTROLS

Know Your Truck

ONE-SPEED HYDRATORK TRANSMISSION

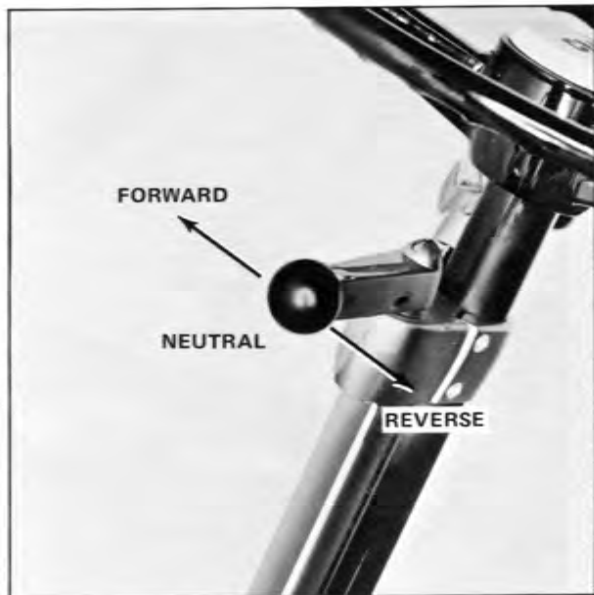

COLUMN MOUNTED CONTROL

13233M

USED IN MODELS: C500 20, 25 S30
C500 20P, 25P
C500 Y 20, 25, 30

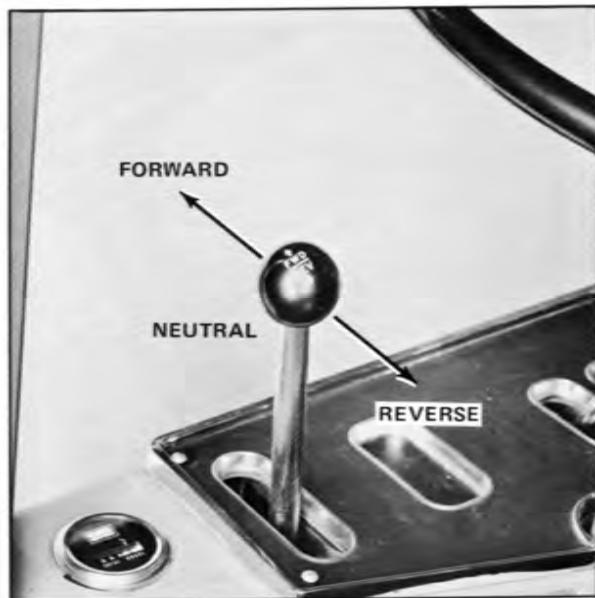

CONSOLE MOUNTED CONTROL

13234M

USED IN MODELS: C500 30 thru 55

TRANSMISSION CONTROLS

Know Your Truck

TWO-SPEED HYDRATORK TRANSMISSION

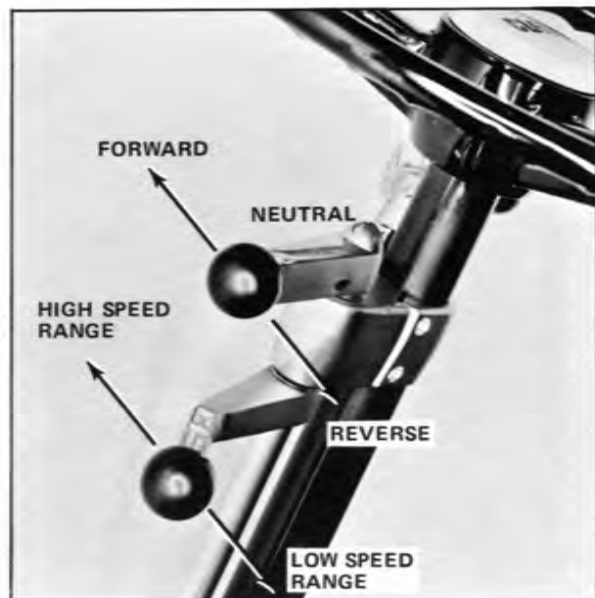

COLUMN MOUNTED CONTROLS

13235M

USED IN MODELS:

C500 60, 70, 80, S80, S90, S100
C500 Y 60, 70, 80, S80, S90, S100

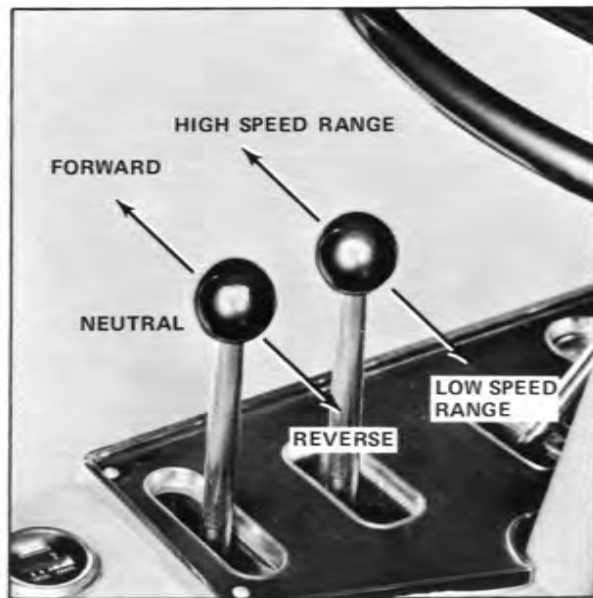

CONSOLE MOUNTED CONTROLS

13236M

USED IN MODELS: C500 Y 40 thru 55

TRANSMISSION CONTROLS

Operating The Hydratork Transmission

The Hydratork is a power-shift transmission . . . not an automatic. It consists of a torque converter and hydraulically actuated selector packs. The selector packs eliminate the need for a clutch pedal. Each control lever position selects only one drive gear ratio.

Operating procedure is as follows:

1. Place forward-reverse control lever in the neutral position and start engine. (See engine starting procedure — pages 42, 43, 44). The service brake pedal should be depressed.

NOTE: If the engine can be started with the control lever in a direction position, report to the proper authority.

2. Move forward-reverse lever to selected direction of travel. Change direction selector lever only when truck is stopped.

3. On two speed models, select speed range. It is recommended that the low range be used when starting, negotiating grades, and driving over unimproved surfaces. Then, change to the high speed range as conditions permit. Speed ranges can be changed while moving.

NOTE: When changing speed ranges, learn to regulate engine speed to minimize load jarring shocks. Decrease engine speed when changing from low to high and increase engine speed when changing to low.

4. Accelerate as required.
5. Inching with the left foot pedal is described on page 28.

Operating The Manual Shift Transmission

The manual shift transmissions are similar to automotive except two control levers are provided. One to select the direction of travel; the other to select operating speed range.

The Hydracool models have a power assisted clutch, the power assist functions only when the engine is running. If during operation a significant increase in effort to depress the clutch pedal is noticed . . . stop the truck immediately as serious damage to the clutch facings may result. Report condition to the proper authority.

Operating procedure is as follows:

1. Place forward-reverse lever in neutral and start engine. (See engine starting procedure — pages 42, 43, 44). Hydracool transmissions are equipped with a neutral-start switch. If the engine can be started with the control lever in a direction position, report to the proper authority.
2. Depress clutch pedal. Move forward-reverse lever to the selected travel position.

3. Move speed range lever to select gear ratio that suits operating conditions. It is recommended that low gear be used when starting, negotiating grades, and when driving over unimproved surfaces.
4. Slowly engage clutch and accelerator as required. Then, change to higher speed range(s) as conditions permit.

NOTE: On two speed models with column mounted controls, speed ranges cannot be changed while truck is moving.

5. On most models, speed ranges can be changed while traveling except truck must be completely stopped when shifting into the lowest range. Depress clutch pedal when changing gears and release with a steady motion. Properly regulate engine speed to obtain maximum smoothness.

CAUTION: Always come to a complete stop when shifting to opposite direction of travel.

Know Your Truck

TWO-SPEED MANUAL SHIFT TRANSMISSION

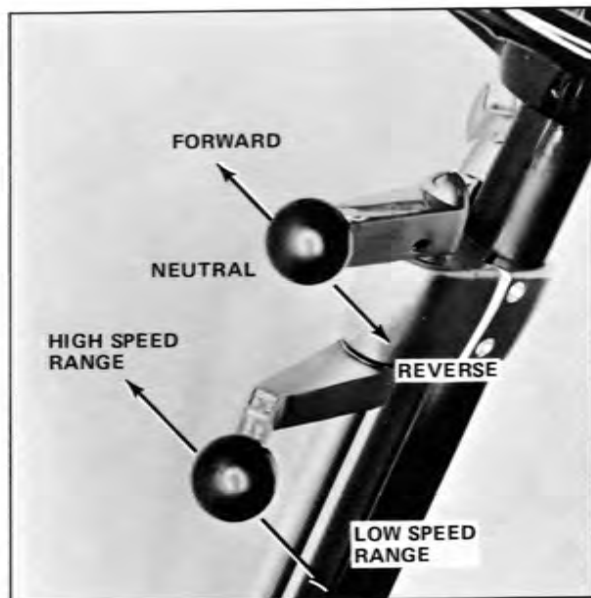

COLUMN MOUNTED CONTROLS

13235M

USED IN MODELS: C500 F 20, 25, S30
C500 F 20P, F 25P
C500 FY 20, 25, 30

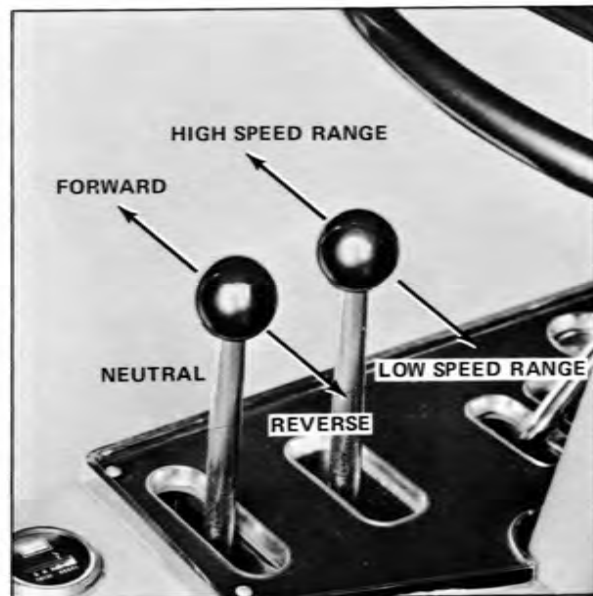

CONSOLE MOUNTED CONTROLS

13236M

USED IN MODELS: C500 H 30 thru 55

TRANSMISSION CONTROLS

Know Your Truck

THREE-SPEED MANUAL SHIFT TRANSMISSION

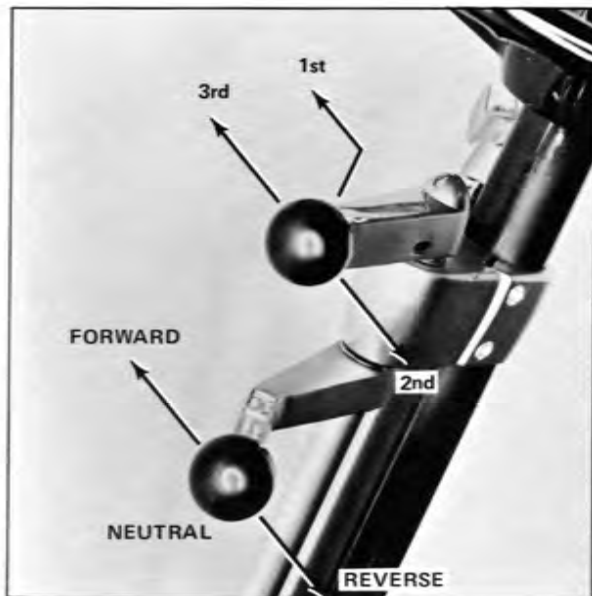

COLUMN MOUNTED CONTROLS

13237M

USED IN MODELS: C500 H 60, 70, 80
C500 HY 60, 70, S80, 80

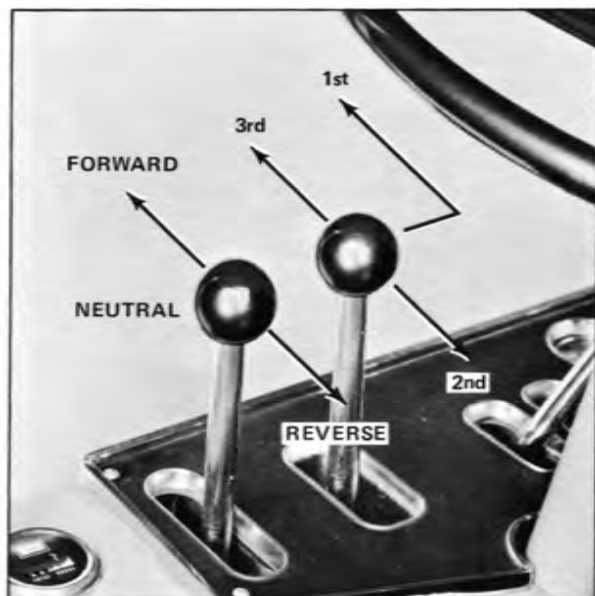

CONSOLE MOUNTED CONTROLS

13238M

USED IN MODELS: C500 HY 40 thru 55

TRANSMISSION CONTROLS



Operator's Daily Checklist

One of your most important functions in making certain your lift truck is in safe and efficient operating condition is to make a quick and easy check at the beginning of your shift.

This should be viewed not only as a maintenance function, but also as a necessary step in doing everything possible to improve safety.

The Daily Checklist . . . available from your Clark Dealer . . . should be used to check out the truck . . . then make certain the report is given to your Maintenance Department (or to the designated authority). The various checks are as follows:

<input checked="" type="checkbox"/>	Boxes Accordingly	<input type="checkbox"/>	OK	<input type="checkbox"/>	Needs Attention or Repair
-------------------------------------	-------------------	--------------------------	----	--------------------------	---------------------------

Visual Checks:		Operational Checks:	
<input type="checkbox"/>	Engine oil level	<input type="checkbox"/>	Horn
<input type="checkbox"/>	Radiator water level	<input type="checkbox"/>	Steering
<input type="checkbox"/>	Fuel level	<input type="checkbox"/>	Service brakes
<input type="checkbox"/>	Obvious damage and leaks	<input type="checkbox"/>	Parking brake
<input type="checkbox"/>	Tire condition	<input type="checkbox"/>	Hydraulic controls
<input type="checkbox"/>	Head and tail lights	<input type="checkbox"/>	
<input type="checkbox"/>	Warning lights	<input type="checkbox"/>	
<input type="checkbox"/>	Hour meter	<input type="checkbox"/>	
<input type="checkbox"/>	Other gauges and instruments	<input type="checkbox"/>	

Operator's Daily Checklist

1. Engine oil level should be maintained between the "add" and "full" marks. The best time to check is before starting the engine or as the last item on the list. This allows accumulated oil to drain back into the crankcase. One quart of oil will raise the level from the "add" mark to "full".
2. Fuel level must be checked with the key switch in the "on" position. Gauge does not necessarily return to empty with switch "off".
3. Obvious damage and leaks. Check for leaks in the hydraulic system, engine and transmission oil, fuel, engine coolant, and power steering where applicable. If the truck has been standing for a length of time, inspect floor for fresh drippings.
- 3A. On 2000-Lb. capacity machine with clutch — turn clutch throwout bearing grease cup cap 1/4 turn clockwise every 8 hours.
4. Tire condition is important for safe operation of any vehicle. Remove all foreign material lodged in tires. Report to designated authority any deep cuts or gouges.

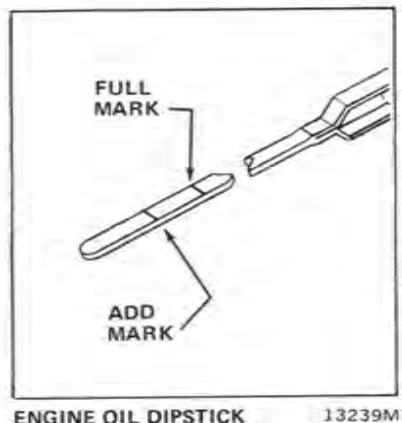

Operator's Daily Checklist

5. Always check radiator coolant level with the engine turned off. When possible with engine cold.

Depending on radiator design, coolant level may be checked in one of the following ways:

TRUCK MODELS:

- A. C500 - (F) (H) Y20 thru 55
C500 - (H) 30 thru 55
- B. C500 - (F) 20 thru S30
C500 - (F) 20P, C500 - (F) 25P
C500 - (H) 60 thru 100S
- C. C500 - (H) Y 60 thru 100S

FILL TO:

- Marker tab
- 1" below filler neck
- Just visible in filler hose



CHECK RADIATOR
COOLANT LEVEL

13240M

Never add cold water or cold anti-freeze into the radiator of an overheated engine. Allow the engine to cool and avoid the danger of cracking the cylinder head or block. Keep engine running while adding water or anti-freeze. A solution of 50% Ethylene Glycol and 50% water is recommended. Never use only water.

CAUTION: Use extreme care when removing radiator pressure cap. The sudden release of pressure can cause a steam flash resulting in serious injury. Place a rag over cap and loosen slowly to allow gradual escape of steam.

Operator's Daily Checklist



**DIESEL AIR CLEANER
CONDITION INDICATOR** 13247M

6. Check all gauges and instruments at beginning of each shift and during operation. Perkins Diesel powered trucks are equipped with an air cleaner condition indicator. If the indicator registers red, the air cleaner must be serviced. The indicator can be reset by pushing the button on top.
7. Head and tail lights must function. Clean if necessary.

8. Check all warning lights and other safety devices.
9. Record hour meter reading on daily checklist.
10. Make sure horn is working correctly, for safety.
11. Make a steering performance check . . . rotate hand wheel back and forth. Excessive travel, looseness or binding should be reported to the proper authority.



STEERING CHECK 13241M

Operator's Daily Checklist

12. Service brake pedal should feel firm when depressed and not noticeably drift with pressure applied for 10 seconds.

On machines equipped with a Hydratork transmission, the same test should be applied to the left foot inching-brake pedal.

If a significant increase in pedal effort is required to stop the truck, report condition to designated authority.



PARKING BRAKE

13242M

13. Check parking brake performance by moving brake lever from full forward to full back position. Maximum force is required just before full back (brake on) position is reached.

The parking brake should hold the truck with a capacity load on a 15% grade (1.5 feet rise in 10 feet), or the maximum grade negotiated in the operation, whichever is less. Brake holding power can be adjusted by rotating the knob on the lever. Rotating clockwise will increase tension; counterwise will reduce tension and holding power.

If performance checks are not satisfactory, report condition to designated authority.

Operator's Daily Checklist

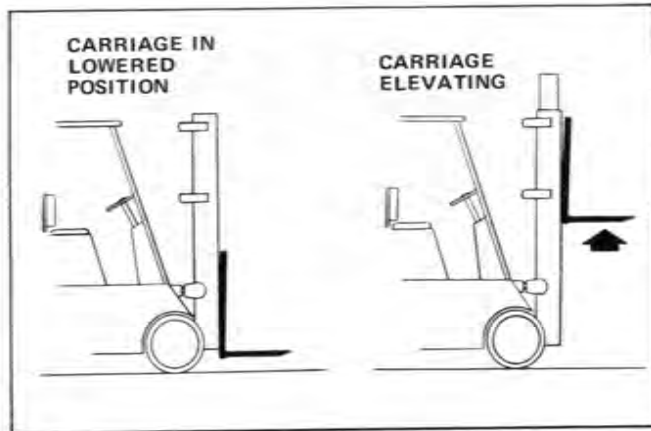

13243M

14. Check hydraulic functions with engine running. (Engine starting procedure is outlined on pages 42, 43 and 44).

All movements of upright and carriage should be smooth, without binding. Hydraulic control lever operations are described on pages 26 and 27.

Tilt upright to full forward and back positions.

Raise carriage to maximum height. If carriage will not reach upper limit, a low hydraulic fluid level is indicated.

Report any unusual operating conditions or noises to the designated authority.

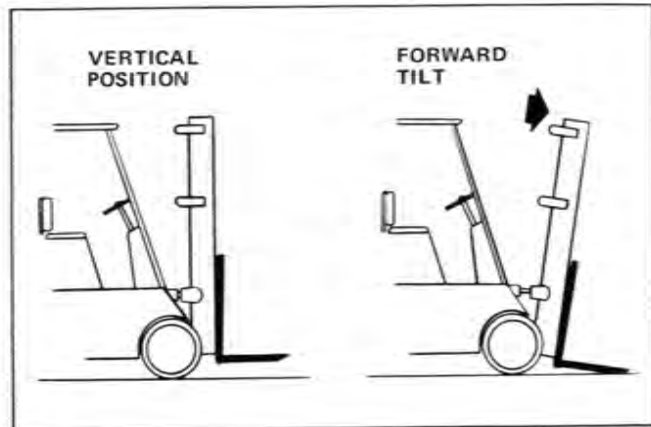

13244M

Engine Starting Procedure Gasoline and L.P. Gas

1. Be sure that forward-reverse transmission control lever is in neutral and parking brake is applied.
2. On L.P. Gas units, open the shut-off valve slowly. If opened too quickly, an automatic safety check valve will close. It will then be necessary to close hand valve for several minutes and slowly open again.

The hand valve opens by turning counter-clockwise.



L.P. GAS
SHUT-OFF VALVE

13245M

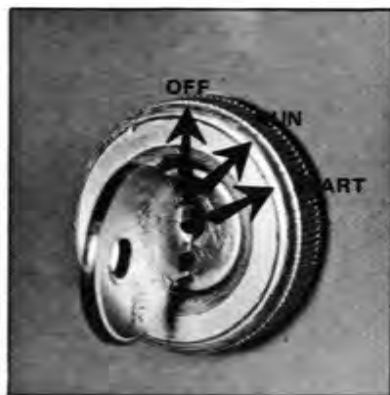

KEY SWITCH

13226M

3. Pull out on choke control.
4. Turn ignition switch key to "start" position to engage starter. Release to "run" position when engine starts.

CAUTION: If engine does not start on first attempt, do not restart until engine comes to a complete stop (about 5 seconds).

Engine Starting Procedure Gasoline and L.P. Gas

5. Push choke control in on gas engine as it warms up to normal operating temperature. The choke should be pushed in immediately after starting L.P. Gas engine.
6. If the engine becomes flooded, push choke control in and fully depress accelerator. Turn key switch . . . engine should now start.
7. With engine running, re-check all instruments and gauges to make sure they are operating properly. Especially note the engine oil pressure indicator. If pressure does not build up immediately, shut off engine and report condition to designated authority.

NOTE: Run engine for several minutes before operating to allow adequate lubrication to reach all moving parts . . . especially in cold operating conditions.

WORK SAFELY

DRIVE SAFELY

BE CAREFUL

Engine Starting Procedure

Diesel

1. Make sure engine "stop" control is in "run" position (pushed in).
2. Place transmission forward and reverse control levers in neutral.
3. Turn key-start switch to "start" position and hold for 15 seconds or until engine starts.
4. If engine does not start, turn key to "off" position and wait for engine to come to complete rest (about 5 seconds).
5. If engine does not start after three tries, air in the fuel system may be the cause. Refer to designated authority and consult P.M. Manual.
6. The Perkins Diesel has a cold starting aid, consisting of a manifold heater. If the weather is cold, depress the "heat-start" button for 15 seconds with the key in "run" position. Now crank engine by turning key to "start".
If engine does not start, repeat procedure holding "heat-start" button in for 10 seconds.

At temperatures below 0°F.(-18°C), depress button for an additional 10 seconds while engine is running.

If engine fails to start, refer to Step 5.

CAUTION: Do not attempt to start engine with fuel tank empty.



DIESEL FUEL
HEATER BUTTON

13246M

Stopping and Parking

1. Gasoline – Lower forks, or other engaging means, to floor with upright tilted slightly forward. Turn key switch to “off” position and set parking brake. Place transmission controls in neutral. Remove key if leaving truck.
2. L.P. Gas – same as 1. If truck is to be parked more than one hour, close manual shut-off valve at tank and continue to run engine until gas vapors in the system are used up. Then turn key to “off”.
3. Diesel – same as 1. Allow engine to idle for several moments before pulling out engine stop control. Be sure to push stop control in after engine stops.
4. Park trucks only in designated areas. Do not block aisles or other emergency lanes.
5. If truck must be left on incline, always block drive wheels to prevent accidental roll.
6. **WARNING:** It is recommended that LPG tanks be stored outside overnight. Only trained and designated personnel should handle LPG containers. Damaged containers can result in a serious accident.
7. The storage and handling of liquid petroleum gas fuel shall be in accordance with the recommendations of the local authority having jurisdiction.

Helpful Hints



RESERVE FUEL VALVE 13248M

Most models (except L.P. Gas trucks and C500 (H) Y 60, 70, S80, 80) are equipped with a reserve fuel supply. If fuel runs low, turn lever from "run" (normal) to "EM" (auxiliary) position. This provides about 1/2 gallon of additional supply to return to refueling area. Do not forget to turn lever back to "run" position. If Diesel fuel is used up, do not attempt to start engine until system has been bled.

Before filling gas tank, make certain filler cap is in place and visually inspect screen for damage.

- Smoking or any open flame is prohibited in fueling area.
- Refuel only at designated areas.
- Never operate vehicle with a leaking fuel system. Report condition to designated authority.



FUEL FILLER CAP 13249M

Helpful Hints



QUICK-DISCONNECT
COUPLING 13250M

To Exchange L.P. Gas Tanks –

1. Close container valve by turning to the right (clockwise).
2. Operate engine until it stops. All gas vapors between tank and carburetor should now be burned. Turn key switch off.
3. Disconnect fuel line at quick-disconnect coupling. Tools should not be required to connect or disconnect coupling.

4. Loosen container fasteners . . . swing and lift up container mounting cover . . . remove container.
5. Replace with recharged container by reversing above procedure. Make sure that tank locating hole is secured over the positioning pin in the tank cover.
6. Open tank valve slowly to ensure that automatic safety check valve does not cut off fuel supply. See Page 42.



TANK POSITIONING-PIN 13251M

Helpful Hints

- **FUEL RECOMMENDATIONS**

Gasoline	85 Octane Minimum (Motor Method)
L.P. Gas	HD 5 Propane
Diesel Fuel	ASTM No. 1 or No. 2 (45 Centane Minimum)

- **ENGINE CRANKCASE OIL**

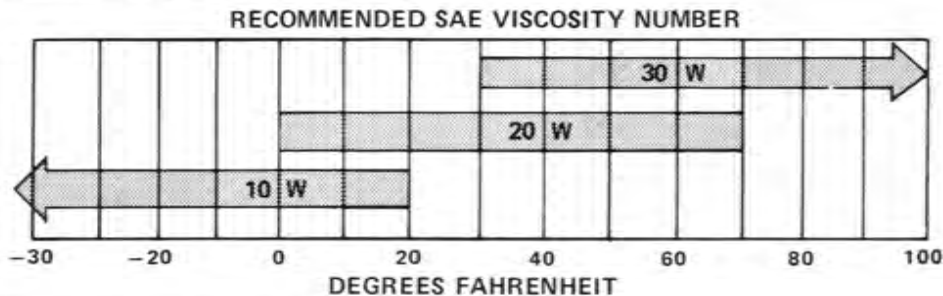

Check PM manual for oil specifications.

Wheel and Tire Maintenance

 DANGER
RIM SEPARATION
REMOVE THE AIR FROM TIRES BEFORE DOING ANY WORK ON TIRES OR RIMS. MULTI-PIECE RIMS CAN SEPARATE WITH ENOUGH FORCE TO CAUSE INJURY OR DEATH.

Federal and State laws require persons to be fully trained and qualified before doing maintenance on wheels and tires. Injury or death can result from the explosive separation of rim components if service procedures are not done correctly.



24309

2. Inspect wheels, tires and mounting parts for condition and security daily.

Wheel and Tire Maintenance



18924

2. Inspect wheels, tires and mounting parts for condition and security daily.



24307

3. Do not stand in front of or in the trajectory path of wheels when checking or adding air pressure. Stand to the side and use a gauge with a long handle and a self attaching air chuck on the hose.

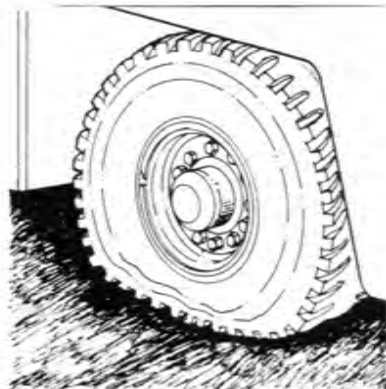

24308

4. Do not put air into a tire which has gone flat or has less than 80 percent of recommended pressure. Check for cause of air loss and confirm that the wheel and tire are safe to use.

Wheel and Tire Maintenance



18631

5. Remove air from the tire before removing wheel clamping nuts (two piece wheels) or rim locking rings on multi-piece rims.



24306

6. Always use a safety cage to inflate tires after servicing. Tire pressures for Y20/Y30, Y60(D)/Y80(D) and YS80(D) are as follows:
Drive: [690 kPa] 100 PSI
Steer: [690 kPa] 100 PSI
Tire pressures for Y40(D)/Y55(D) and YS60(D) are as follows:
Drive: [862 kPa] 125 PSI
Steer: [827 kPa] 120 PSI
Tire pressures for Y90(D) and Y100(D) are as follows:
Drive: [827 kPa] 120 PSI
Steer: [690 kPa] 100 PSI



24964

7. Check tire pressure from a position facing the tread of the tire, not the side. Use a long handled gauge to keep your body away from the side.

If tires are low, do not add air. Check with a mechanic. The tire may need to be removed and repaired.

SERIAL NUMBERS:

TRUCK _____

ENGINE _____

STEER AXLE _____

TRANSMISSION _____

UPRIGHT _____



Additional copies of this manual may be purchased from
YOUR AUTHORIZED CLARK DEALER

CLARK[®] Material Handling
Company

Lexington, KY 40511
Printed in USA